

# PHC 10B-2C/L

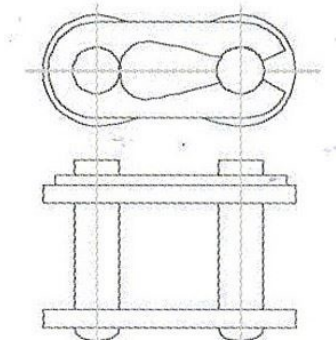

Type of link	C/L
--------------	-----