

# PHC 08B-2C/L

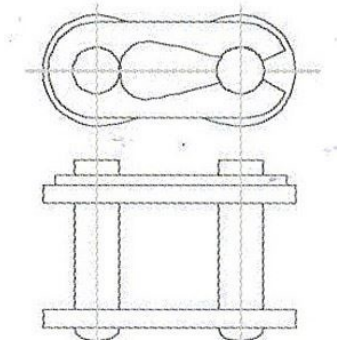

Type of link	C/L
--------------	-----