

# PHC 04B-1C/L

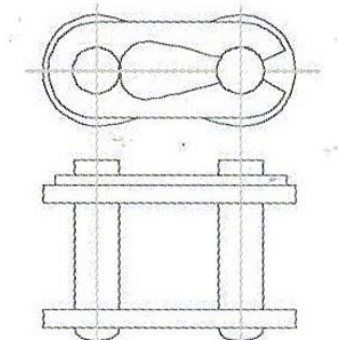

Type of link	C/L
--------------	-----