

PCMF 151709 E

Dimensions

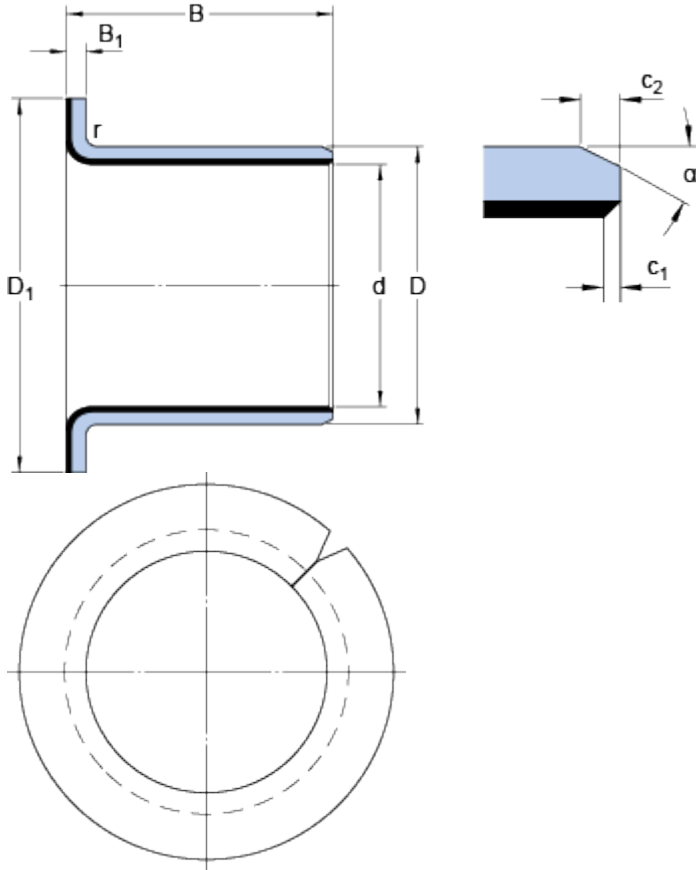

d		15	mm
D		17	mm
B		9	mm
D ₁		23	mm
B ₁		1	mm
c ₁	min.	0.1	mm
c ₁	max.	0.6	mm
c ₂	min.	0.2	mm
c ₂	max.	1	mm
α	±8	20	°
r	max.	1	mm

Recommended fits

Tolerance shaft	f7
Tolerance housing	H7

Calculation data

Basic dynamic load rating - radial direction	C	8.3	kN
Basic static load rating - radial direction	C	26	kN
Basic dynamic load rating - axial direction	C _a	10.4	kN
Basic static load rating - axial direction	C _{0a}	32.5	kN
Specific dynamic load factor	K	80	N/mm ²
Specific static load factor	K	250	N/mm ²
Factor depending on material and bearing type	K _M	480	
Permissible sliding velocity	v	min. 0	m/s
Permissible sliding velocity	v	max. 2	m/s
Coefficient of friction	μ	min. 0.03	
Coefficient of friction	μ	max. 0.25	

Mass

Mass bushing	0.0042	kg
--------------	--------	----

