

PCMF 060804 E

Dimensions

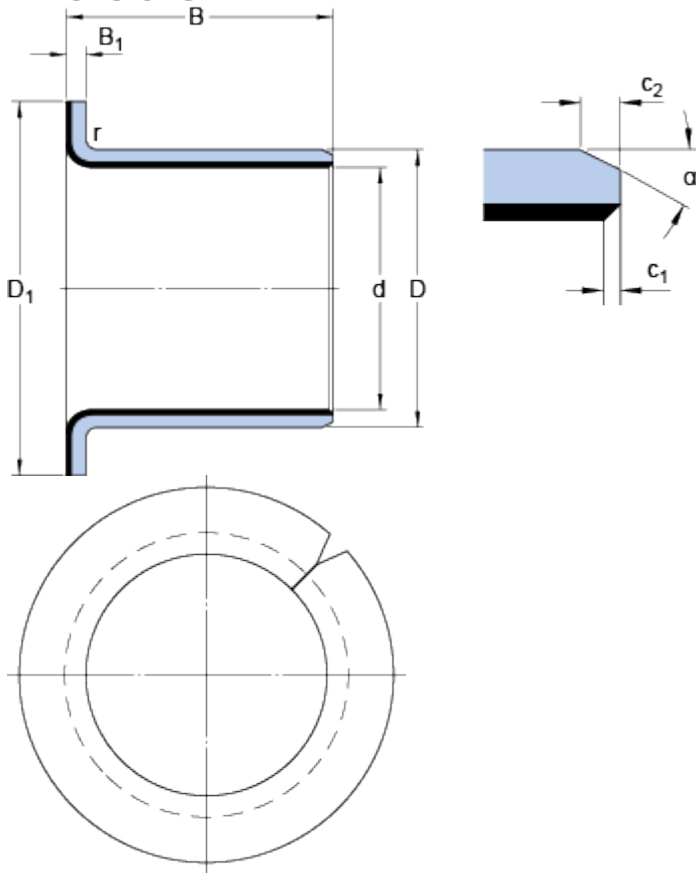

d	6	mm
D	8	mm
B	4	mm
D ₁	12	mm
B ₁	1	mm
c ₁	min. 0.1	mm
c ₁	max. 0.7	mm
c ₂	min. 0.2	mm
c ₂	max. 1	mm
α	±8	20 °
r	max. 1	mm

Recommended fits

Tolerance shaft	f7
Tolerance housing	H7

Calculation data

Basic dynamic load rating - radial direction	C	0.965	kN
Basic static load rating - radial direction	C	3	kN
Basic dynamic load rating - axial direction	C _a	2.75	kN
Basic static load rating - axial direction	C _{0a}	8.65	kN
Specific dynamic load factor	K	80	N/mm ²
Specific static load factor	K	250	N/mm ²
Factor depending on material and bearing type	K _M	480	
Permissible sliding velocity	v	min. 0	m/s
Permissible sliding velocity	v	max. 2	m/s
Coefficient of friction	μ	min. 0.03	
Coefficient of friction	μ	max. 0.25	

Mass

Mass bushing	0.0013	kg
--------------	--------	----

