

NU 209 ECJ

SKF Explorer

Dimensions

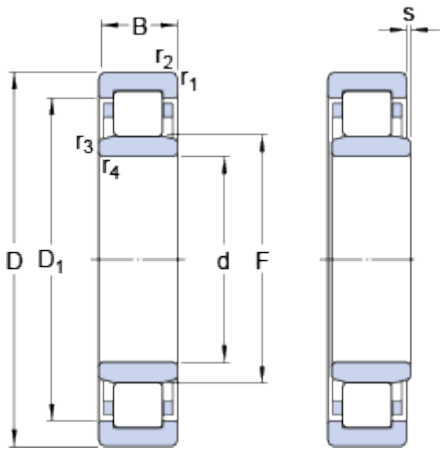

d		45	mm
D		85	mm
B		19	mm
D ₁	≈	72.4	mm
F		54.5	mm
r _{1,2}	min.	1.1	mm
r _{3,4}	min.	1.1	mm
s	max.	1.2	mm

Abutment dimensions

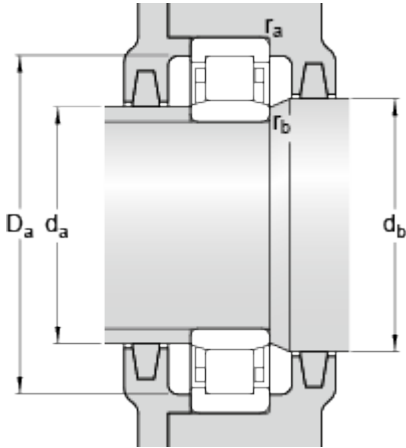

d _a	min.	52	mm
d _a	max.	53	mm
d _b	min.	56	mm
D _a	max.	77.6	mm
r _a	max.	1	mm
r _b	max.	1	mm

Calculation data

Basic dynamic load rating	C	69.5	kN
Basic static load rating	C	64	kN
Fatigue load limit	P _u	8.15	kN
Reference speed		9000	r/min
Limiting speed		9500	r/min
Calculation factor	k _r	0.15	
Limiting value	e	0.2	
Axial load factor	Y	0.6	

Mass

Mass bearing		0.43	kg
--------------	--	------	----

Associated products

Angle ring		HJ 209 EC	
------------	--	---------------------------	--

