

NUP 309 ECP

SKF Explorer

Dimensions

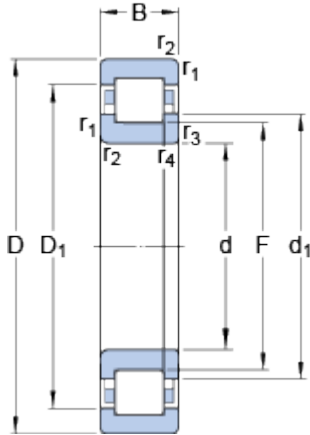

d		45	mm
D		100	mm
B		25	mm
d ₁	≈	64.4	mm
D ₁	≈	83.2	mm
F		58.5	mm
r _{1,2}	min.	1.5	mm
r _{3,4}	min.	1.5	mm

Abutment dimensions

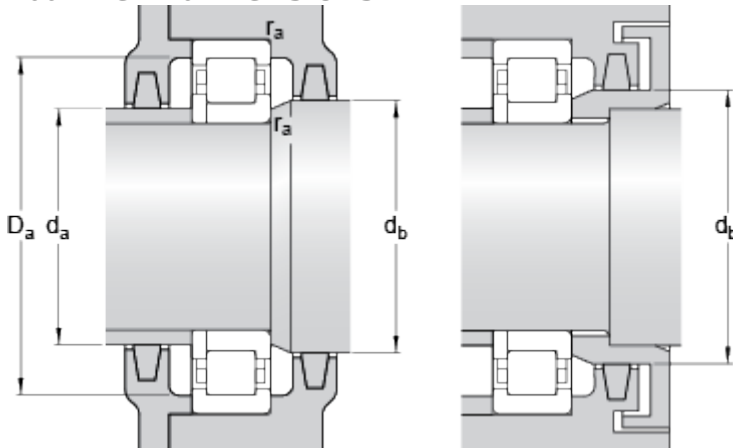

d _a	min.	54	mm
d _b	min.	67	mm
D _a	max.	91.4	mm
r _a	max.	1.5	mm

Calculation data

Basic dynamic load rating	C	112	kN
Basic static load rating	C	100	kN
Fatigue load limit	P _u	12.9	kN
Reference speed		7500	r/min
Limiting speed		8500	r/min
Calculation factor	k _r	0.15	
Limiting value	e	0.2	
Axial load factor	Y	0.6	

Mass

Mass bearing		0.93	kg
--------------	--	------	----