

NUP 307 ECP

SKF Explorer

Dimensions

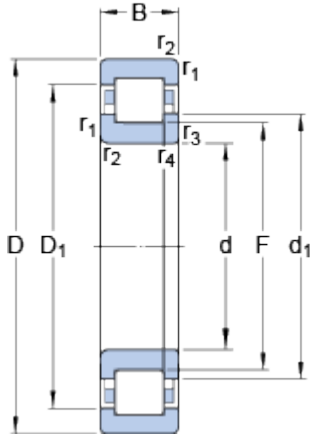

d		35	mm
D		80	mm
B		21	mm
d ₁	≈	51	mm
D ₁	≈	65.8	mm
F		46.2	mm
r _{1,2}	min.	1.5	mm
r _{3,4}	min.	1.1	mm

Abutment dimensions

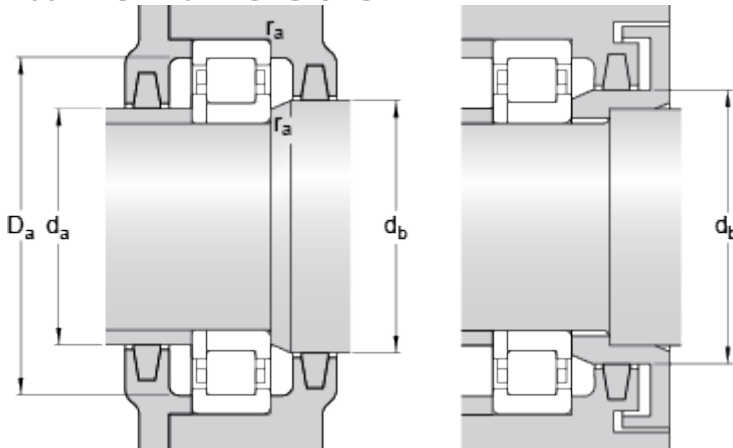

d _a	min.	44	mm
d _b	min.	53	mm
D _a	max.	72.2	mm
r _a	max.	1.5	mm

Calculation data

Basic dynamic load rating	C	75	kN
Basic static load rating	C	63	kN
Fatigue load limit	P _u	8.15	kN
Reference speed		9500	r/min
Limiting speed		11000	r/min
Calculation factor	k _r	0.15	
Limiting value	e	0.2	
Axial load factor	Y	0.6	

Mass

Mass bearing		0.49	kg
--------------	--	------	----