

NUP 2210 ECP

SKF Explorer

Dimensions

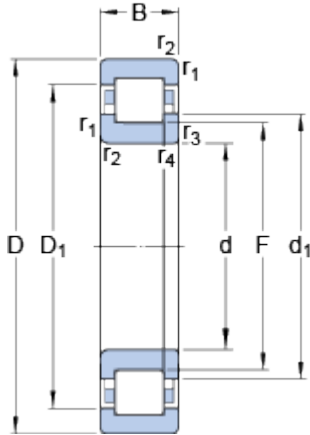

d		50	mm
D		90	mm
B		23	mm
d ₁	≈	64	mm
D ₁	≈	77.4	mm
F		59.5	mm
r _{1,2}	min.	1.1	mm
r _{3,4}	min.	1.1	mm

Abutment dimensions

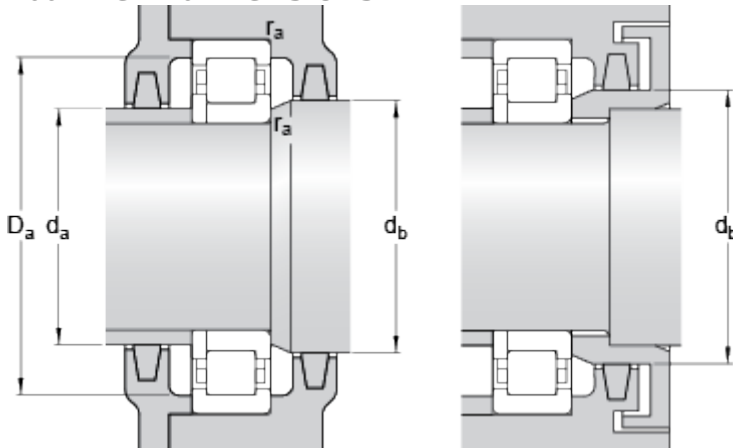

d _a	min.	57	mm
d _b	min.	66	mm
D _a	max.	82.4	mm
r _a	max.	1	mm

Calculation data

Basic dynamic load rating	C	90	kN
Basic static load rating	C	88	kN
Fatigue load limit	P _u	11.4	kN
Reference speed		8500	r/min
Limiting speed		9000	r/min
Calculation factor	k _r	0.2	
Limiting value	e	0.3	
Axial load factor	Y	0.4	

Mass

Mass bearing		0.59	kg
--------------	--	------	----