

NUP 2206 ECP

SKF Explorer

Dimensions

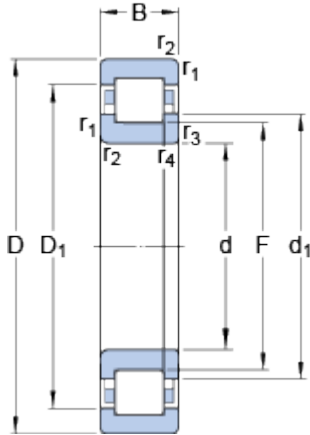

d		30	mm
D		62	mm
B		20	mm
d ₁	≈	41.2	mm
D ₁	≈	51.95	mm
F		37.5	mm
r _{1,2}	min.	1	mm
r _{3,4}	min.	0.6	mm

Abutment dimensions

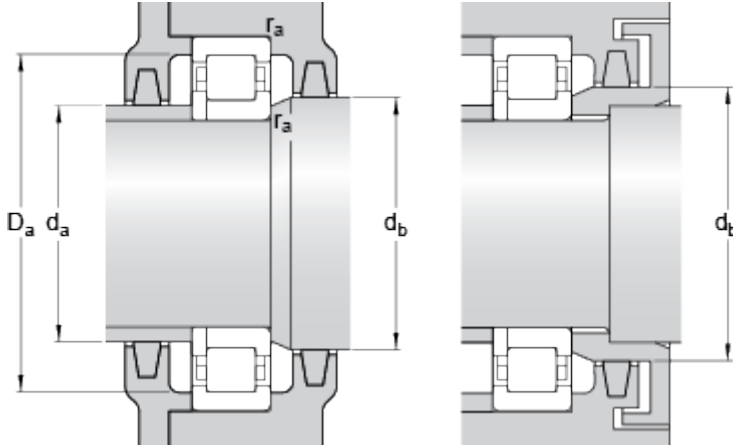

d _a	min.	35.3	mm
d _b	min.	43	mm
D _a	max.	55.9	mm
r _a	max.	1	mm

Calculation data

Basic dynamic load rating	C	55	kN
Basic static load rating	C	49	kN
Fatigue load limit	P _u	6.1	kN
Reference speed		13000	r/min
Limiting speed		14000	r/min
Calculation factor	k _r	0.2	
Limiting value	e	0.3	
Axial load factor	Y	0.4	

Mass

Mass bearing		0.27	kg
--------------	--	------	----