

NA 6913

Dimensions

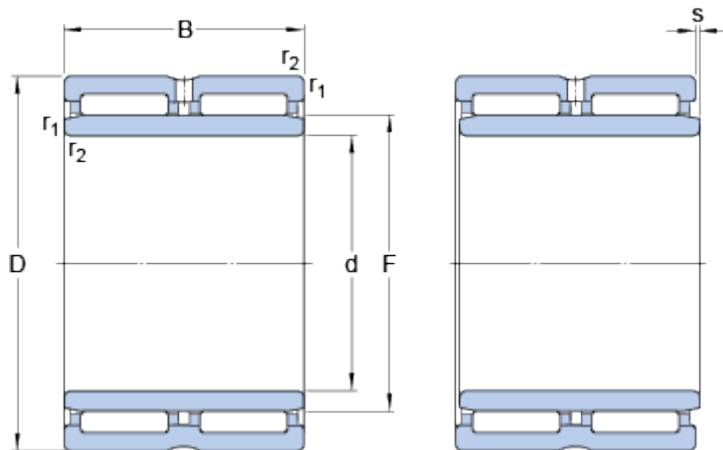

d		65	mm
D		90	mm
B		45	mm
F		72	mm
r _{1,2}	min.	1	mm
s	max.	1.5	mm

Abutment dimensions

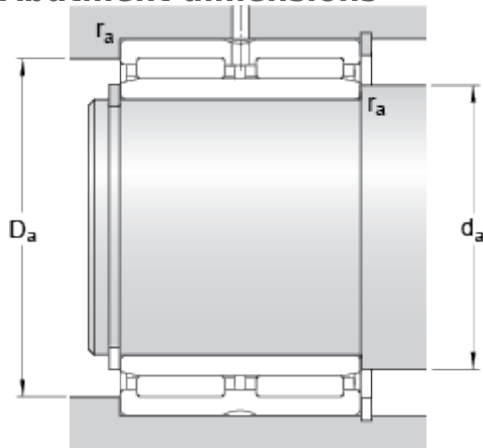

d _a	min.	70	mm
D _a	max.	85	mm
r _a	max.	1	mm

Calculation data

Basic dynamic load rating	C	95.2	kN
Basic static load rating	C	212	kN
Fatigue load limit	P _u	26	kN
Reference speed		5600	r/min
Limiting speed		6300	r/min

Mass

Mass bearing		0.83	kg
--------------	--	------	----