

NA 6911

Dimensions

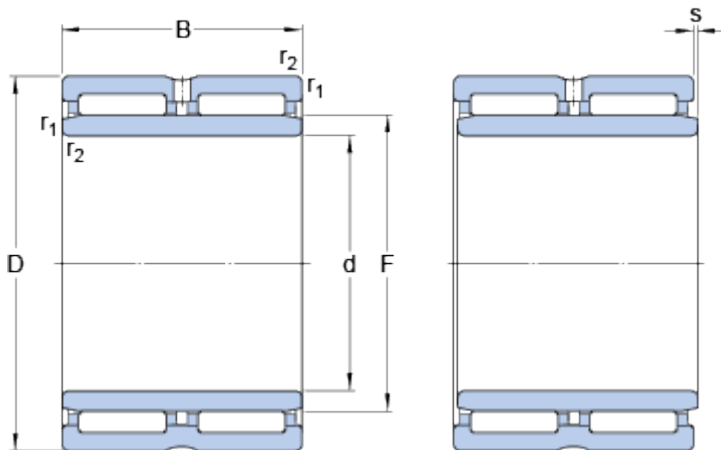

d		55	mm
D		80	mm
B		45	mm
F		63	mm
r _{1,2}	min.	1	mm
s	max.	1.5	mm

Abutment dimensions

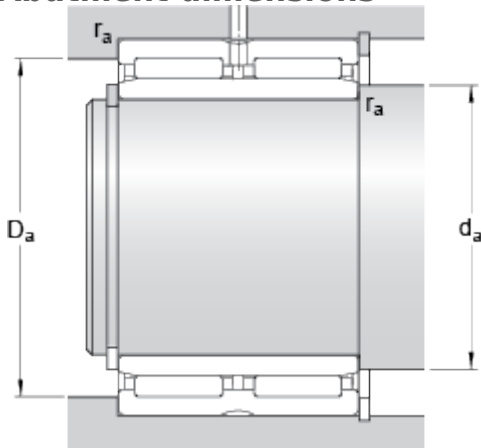

d _a	min.	60	mm
D _a	max.	75	mm
r _a	max.	1	mm

Calculation data

Basic dynamic load rating	C	89.7	kN
Basic static load rating	C	190	kN
Fatigue load limit	P _u	23.2	kN
Reference speed		6300	r/min
Limiting speed		7000	r/min

Mass

Mass bearing		0.78	kg
--------------	--	------	----