

NA 4908

Dimensions

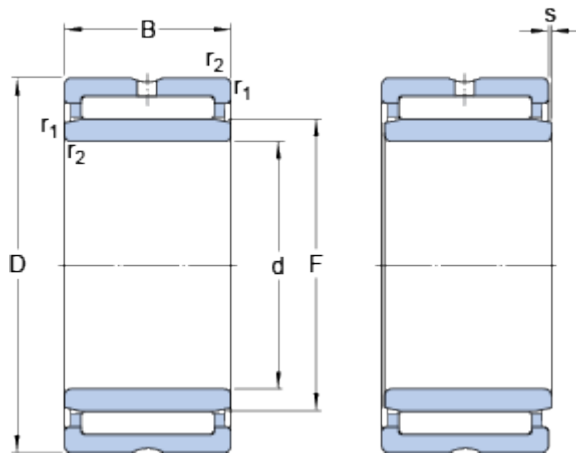

d		40	mm
D		62	mm
B		22	mm
F		48	mm
r _{1,2}	min.	0.6	mm
s	max.	1	mm

Abutment dimensions

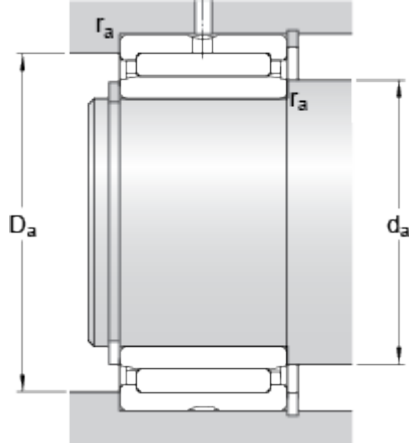

d _a	min.	44	mm
D _a	max.	58	mm
r _a	max.	0.6	mm

Calculation data

Basic dynamic load rating	C	42.9	kN
Basic static load rating	C	71	kN
Fatigue load limit	P _u	8.8	kN
Reference speed		8000	r/min
Limiting speed		9500	r/min

Mass

Mass bearing		0.23	kg
--------------	--	------	----