

NA 4901

Dimensions

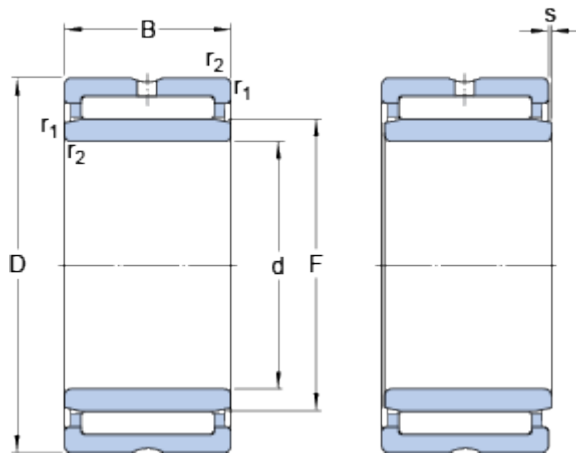

d		12	mm
D		24	mm
B		13	mm
F		16	mm
$r_{1,2}$	min.	0.3	mm
s	max.	0.5	mm

Abutment dimensions

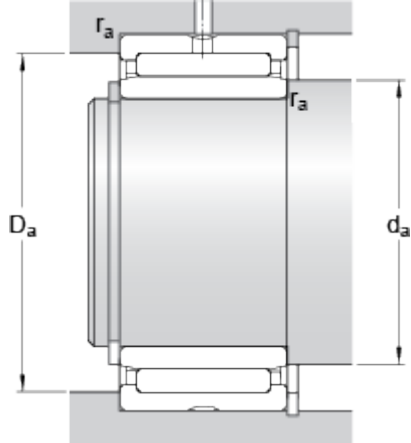

d_a	min.	14	mm
D_a	max.	22	mm
r_a	max.	0.3	mm

Calculation data

Basic dynamic load rating	C	9.9	kN
Basic static load rating	C	12.2	kN
Fatigue load limit	P_u	1.46	kN
Reference speed		22000	r/min
Limiting speed		26000	r/min

Mass

Mass bearing		0.026	kg
--------------	--	-------	----