

NA 4900

Dimensions

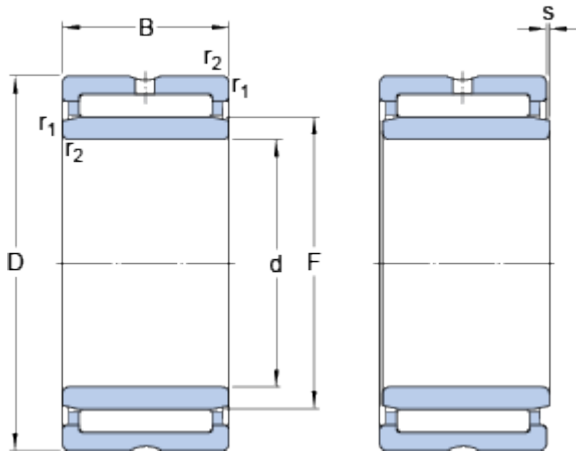

d		10	mm
D		22	mm
B		13	mm
F		14	mm
r _{1,2}	min.	0.3	mm
s	max.	0.5	mm

Abutment dimensions

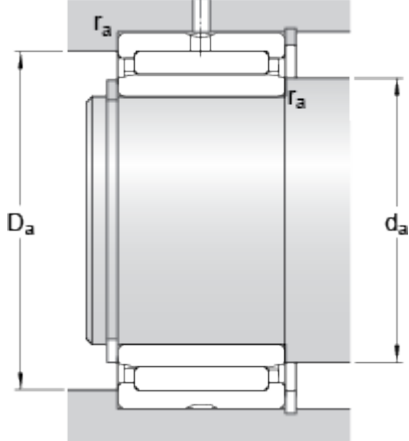

d _a	min.	12	mm
D _a	max.	20	mm
r _a	max.	0.3	mm

Calculation data

Basic dynamic load rating	C	8.8	kN
Basic static load rating	C	10.4	kN
Fatigue load limit	P _u	1.22	kN
Reference speed		24000	r/min
Limiting speed		28000	r/min

Mass

Mass bearing		0.024	kg
--------------	--	-------	----