

NATV 5 PPA

Dimensions

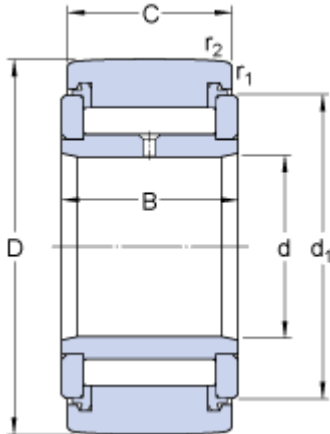

D	16	mm
d	5	mm
C	11	mm
B	12	mm
d ₁	12.5	mm
r _{1,2}	min. 0.15	mm

Calculation data

Basic dynamic load rating	C	4.73	kN
Basic static load rating	C	6.55	kN
Fatigue load limit	P _u	0.72	kN
Maximum dynamic radial loads	F _r	max. 4.05	kN
Maximum static radial loads	F _{0r}	max. 5.7	kN
Limiting speed		4300	r/min

Mass

Mass support roller	0.015	kg
---------------------	-------	----