

NATR 25 PPA

Dimensions

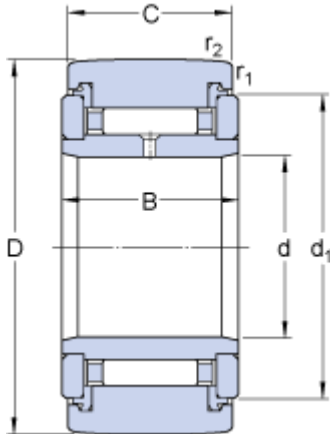

D	52	mm
d	25	mm
C	24	mm
B	25	mm
d ₁	41.5	mm
r _{1,2}	min. 1	mm

Calculation data

Basic dynamic load rating	C	14.7	kN
Basic static load rating	C	25.5	kN
Fatigue load limit	P _u	3.1	kN
Maximum dynamic radial loads	F _r	max. 21.6	kN
Maximum static radial loads	F _{0r}	max. 31	kN
Limiting speed		2400	r/min

Mass

Mass support roller		0.27	kg
---------------------	--	------	----