

KM 27

Dimensions

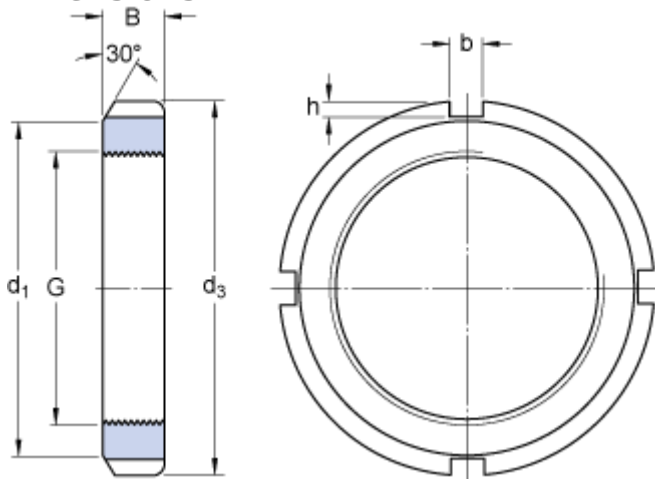

G	M 135x2	
d_3	175	mm
B	22	mm
d_1	160	mm
b	14	mm
h	6	mm

Calculation data

Axial static load carrying capacity 430 kN

Mass

Mass lock nut 1.4 kg

Mounting information

Associated spanner TMFN 23-30

Associated products

Lock washer / Locking clip [MB 27](#)