

# KM 23

## Dimensions

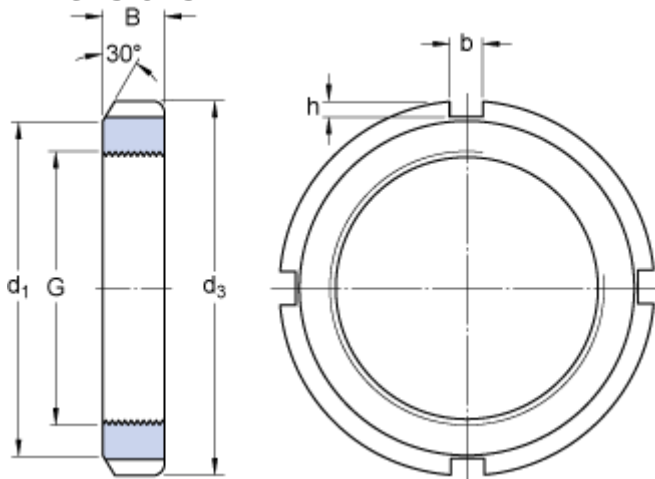

G	M 115x2	
$d_3$	150	mm
B	19	mm
$d_1$	137	mm
b	12	mm
h	5	mm

## Calculation data

Axial static load carrying capacity	315	kN
-------------------------------------	-----	----

## Mass

Mass lock nut	0.91	kg
---------------	------	----

## Mounting information

Associated spanner	TMFN 23-30
--------------------	------------

## Associated products

Lock washer / Locking clip	<a href="#">MB 23</a>
----------------------------	-----------------------