

KMT 7

Dimensions

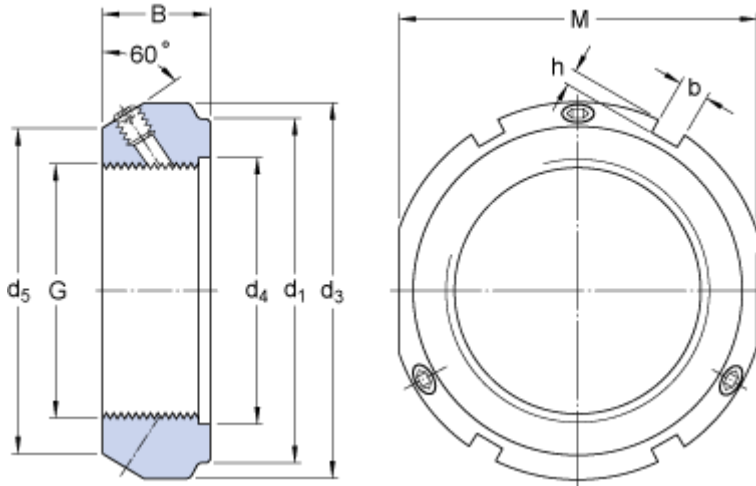

G	M 35x1.5	
d ₁	49	mm
B	22	mm
d ₃	54	mm
d ₄	38	mm
d ₅	46	mm
M	50	mm
b	5	mm
h	2	mm

Calculation data

Axial static load carrying capacity	190	kN
-------------------------------------	-----	----

Mass

Mass	0.19	kg
------	------	----

Mounting information

Associated spanner (Hook spanner in accordance with DIN 1810)	HN 7
Grub (set) / Locking screw size	M 6
Recommended tightening torque	8 N·m