

KMT 14

Dimensions

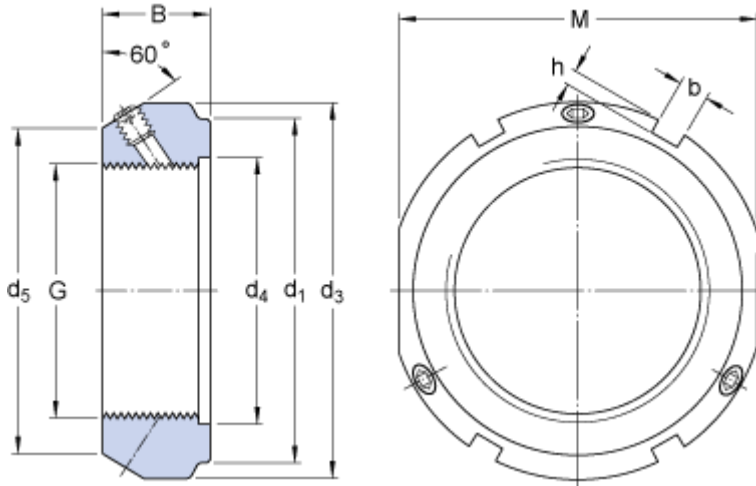

G	M 70x2	
d ₁	92	mm
B	28	mm
d ₃	100	mm
d ₄	72	mm
d ₅	88	mm
M	95	mm
b	8	mm
h	3.5	mm

Calculation data

Axial static load carrying capacity	490	kN
-------------------------------------	-----	----

Mass

Mass	0.75	kg
------	------	----

Mounting information

Associated spanner (Hook spanner in accordance with DIN 1810)	HN 15
Grub (set) / Locking screw size	M 8
Recommended tightening torque	18 N·m