

H 320

Dimensions

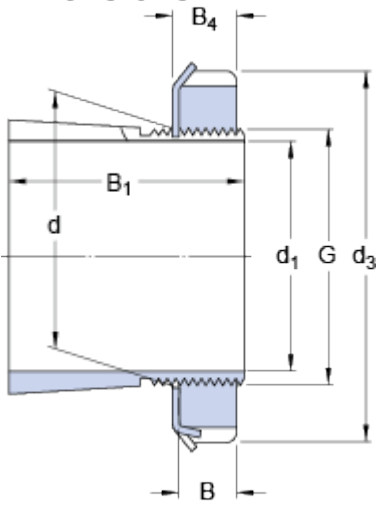

d_1	90	mm
d	100	mm
d_3	130	mm
B_1	71	mm
B	18	mm
B_4	20	mm
G	M 100x2	

Mass

Mass adapter sleeve assembly

1.78

kg

Included products

Lock nut

[KM 20](#)

Locking device

[MB 20](#)

Associated products

Hydraulic nut

[HMV 20 E](#)