

H 317

Dimensions

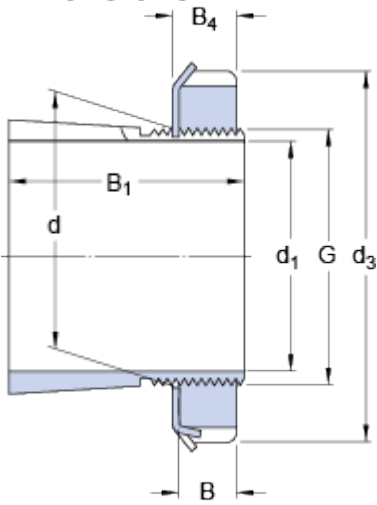

d_1	75	mm
d	85	mm
d_3	110	mm
B_1	63	mm
B	16	mm
B_4	18	mm
G	M 85x2	

Mass

Mass adapter sleeve assembly

1.23

kg

Included products

Lock nut

[KM 17](#)

Locking device

[MB 17](#)

Associated products

Hydraulic nut

[HMV 17 E](#)