

H 313

Dimensions

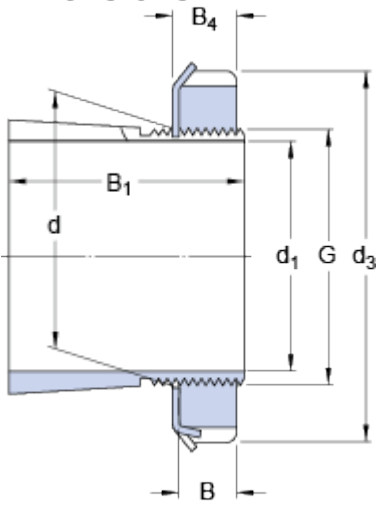

d_1	60	mm
d	65	mm
d_3	85	mm
B_1	50	mm
B	12	mm
B_4	13.5	mm
G	M 65x2	

Mass

Mass adapter sleeve assembly

0.48

kg

Included products

Lock nut

[KM 13](#)

Locking device

[MB 13](#)

Associated products

Hydraulic nut

[HMV 13 E](#)