

# H 3132

## Dimensions

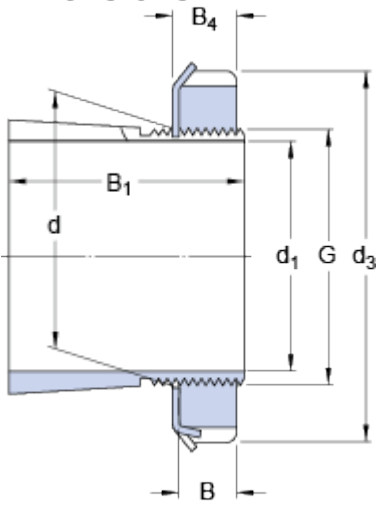

$d_1$	140	mm
$d$	160	mm
$d_3$	210	mm
$B_1$	119	mm
$B$	25	mm
$B_4$	28	mm
$G$	M 160x3	

## Mass

Mass adapter sleeve assembly

7.25

kg

## Included products

Lock nut

[KM 32](#)

Locking device

[MB 32](#)

## Associated products

Hydraulic nut

[HMV 32 E](#)