

H 312

Dimensions

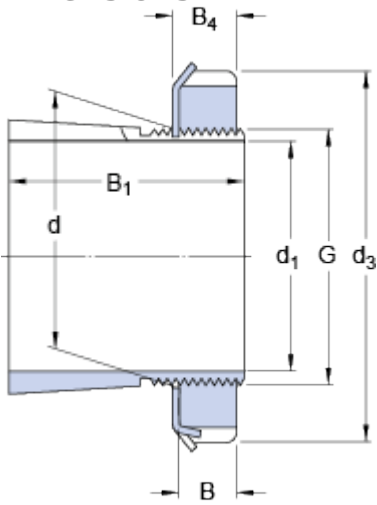

d_1	55	mm
d	60	mm
d_3	80	mm
B_1	47	mm
B	11	mm
B_4	13	mm
G	M 60x2	

Mass

Mass adapter sleeve assembly

0.41

kg

Included products

Lock nut

[KM 12](#)

Locking device

[MB 12](#)

Associated products

Hydraulic nut

[HMV 12 E](#)