

# H 3128

## Dimensions

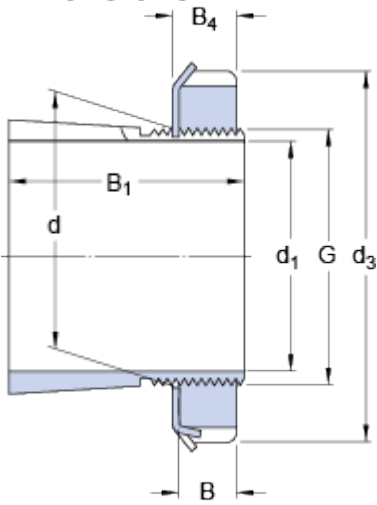

$d_1$	125	mm
$d$	140	mm
$d_3$	180	mm
$B_1$	97	mm
$B$	22	mm
$B_4$	24	mm
$G$	M 140x2	

## Mass

Mass adapter sleeve assembly

4.1 kg

## Included products

Lock nut

[KM 28](#)

Locking device

[MB 28](#)

## Associated products

Hydraulic nut

[HMV 28 E](#)