

# H 3122

## Dimensions

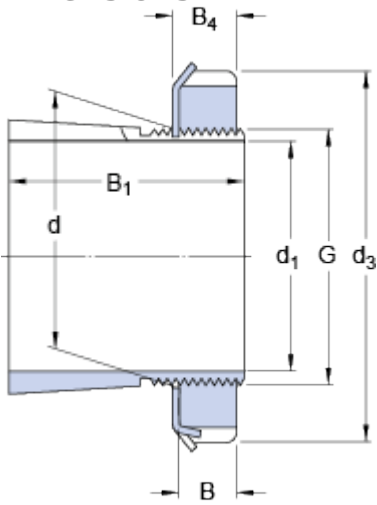

$d_1$	100	mm
$d$	110	mm
$d_3$	145	mm
$B_1$	81	mm
$B$	19	mm
$B_4$	21	mm
$G$	M 110x2	

## Mass

Mass adapter sleeve assembly

2.1 kg

## Included products

Lock nut

[KM 22](#)

Locking device

[MB 22](#)

## Associated products

Hydraulic nut

HMV 22 E