

H 309

Dimensions

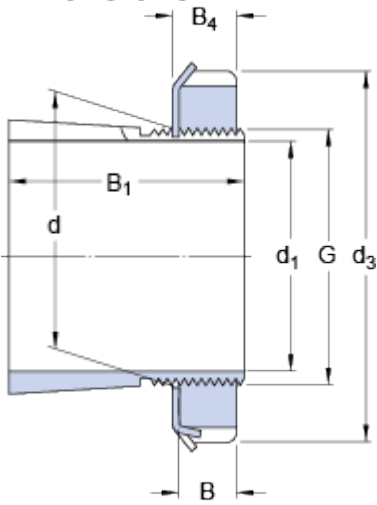

d_1	40	mm
d	45	mm
d_3	65	mm
B_1	39	mm
B	10	mm
B_4	11	mm
G	M 45x1.5	

Mass

Mass adapter sleeve assembly

0.26

kg

Included products

Lock nut

[KM 9](#)

Locking device

[MB 9](#)