

# H 308

## Dimensions

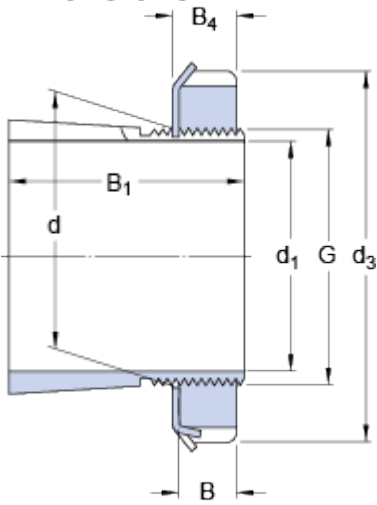

$d_1$	35	mm
$d$	40	mm
$d_3$	58	mm
$B_1$	36	mm
$B$	9	mm
$B_4$	10	mm
$G$	M 40x1.5	

## Mass

Mass adapter sleeve assembly

0.2 kg

## Included products

Lock nut

[KM 8](#)

Locking device

[MB 8](#)