

H 2324

Dimensions

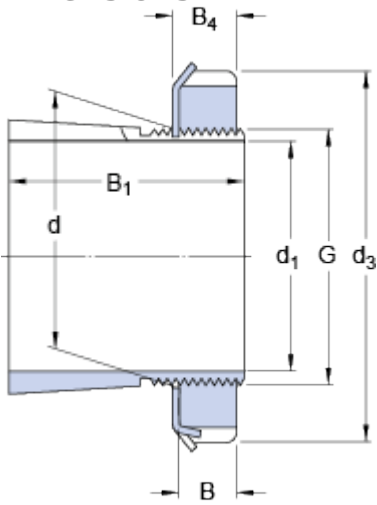

d_1	110	mm
d	120	mm
d_3	155	mm
B_1	112	mm
B	20	mm
B_4	22	mm
G	M 120x2	

Mass

Mass adapter sleeve assembly

3 kg

Included products

Lock nut

[KM 24](#)

Locking device

[MB 24](#)

Associated products

Hydraulic nut

[HMV 24 E](#)