

H 2318

Dimensions

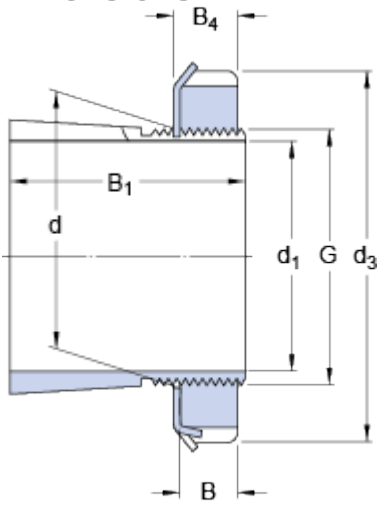

d_1	80	mm
d	90	mm
d_3	120	mm
B_1	86	mm
B	16	mm
B_4	18	mm
G	M 90x2	

Mass

Mass adapter sleeve assembly

1.6 kg

Included products

Lock nut

[KM 18](#)

Locking device

[MB 18](#)

Associated products

Hydraulic nut

HMV 18 E