

# H 2316

## Dimensions

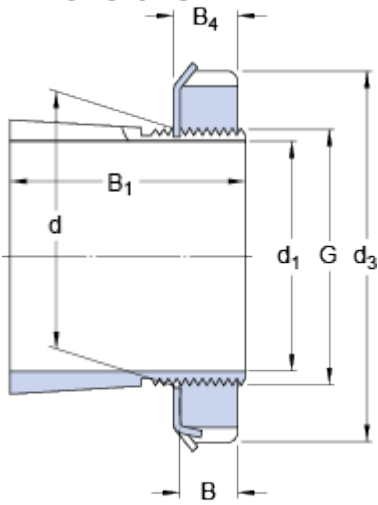

$d_1$	70	mm
$d$	80	mm
$d_3$	105	mm
$B_1$	78	mm
$B$	15	mm
$B_4$	17	mm
$G$	M 80x2	

## Mass

Mass adapter sleeve assembly

1.2 kg

## Included products

Lock nut

[KM 16](#)

Locking device

[MB 16](#)

## Associated products

Hydraulic nut

[HMV 16 E](#)