

H 2315

Dimensions

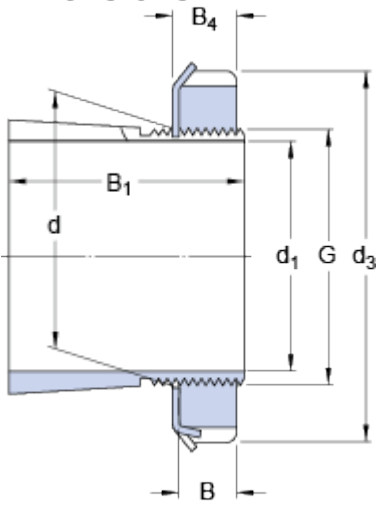

d_1	65	mm
d	75	mm
d_3	98	mm
B_1	73	mm
B	13	mm
B_4	14.5	mm
G	M 75x2	

Mass

Mass adapter sleeve assembly

1.1 kg

Included products

Lock nut

[KM 15](#)

Locking device

[MB 15](#)

Associated products

Hydraulic nut

[HMV 15 E](#)