

# H 2313

## Dimensions

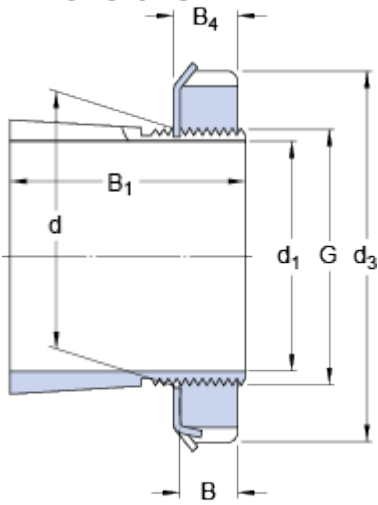

$d_1$	60	mm
$d$	65	mm
$d_3$	85	mm
$B_1$	65	mm
$B$	12	mm
$B_4$	13.5	mm
$G$	M 65x2	

## Mass

Mass adapter sleeve assembly

0.52

kg

## Included products

Lock nut

[KM 13](#)

Locking device

[MB 13](#)

## Associated products

Hydraulic nut

HMV 13 E