

# H 2306

## Dimensions

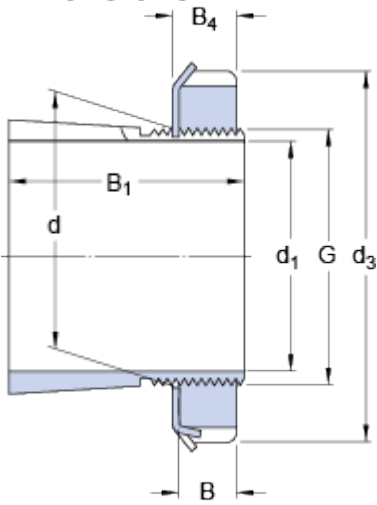

$d_1$	25	mm
$d$	30	mm
$d_3$	45	mm
$B_1$	38	mm
$B$	7	mm
$B_4$	8	mm
$G$	M 30x1.5	

## Mass

Mass adapter sleeve assembly

0.11

kg

## Included products

Lock nut

[KM 6](#)

Locking device

[MB 6](#)