

H 216

Dimensions

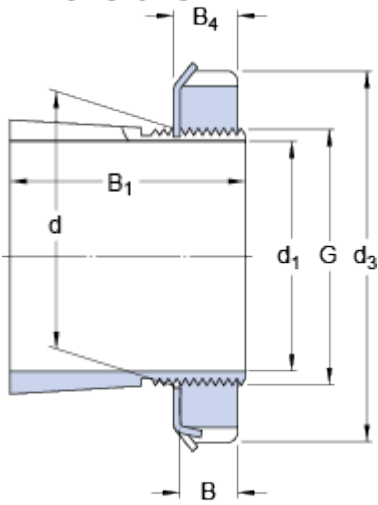

d_1	70	mm
d	80	mm
d_3	105	mm
B_1	46	mm
B	15	mm
B_4	17	mm
G	M 80x2	

Mass

Mass adapter sleeve assembly

0.91

kg

Included products

Lock nut

[KM 16](#)

Locking device

[MB 16](#)

Associated products

Hydraulic nut

[HMV 16E](#)