

H 211

Dimensions

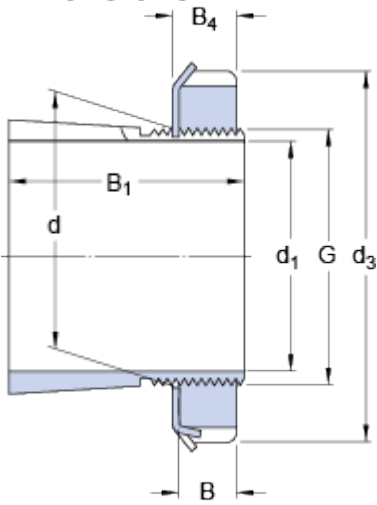

d_1	50	mm
d	55	mm
d_3	75	mm
B_1	37	mm
B	11	mm
B_4	12.5	mm
G	M 55x2	

Mass

Mass adapter sleeve assembly

0.33

kg

Included products

Lock nut

[KM 11](#)

Locking device

[MB 11](#)

Associated products

Hydraulic nut

[HMV 11E](#)