

H 208

Dimensions

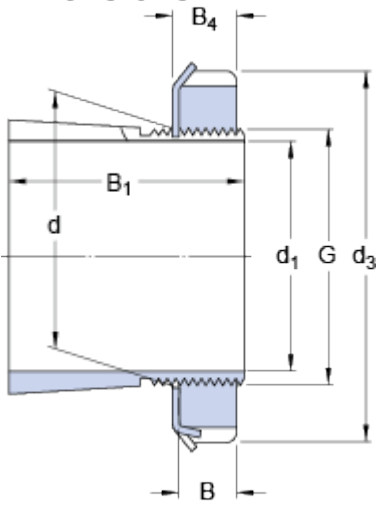

d_1	35	mm
d	40	mm
d_3	58	mm
B_1	31	mm
B	9	mm
B_4	10	mm
G	M 40x1.5	

Mass

Mass adapter sleeve assembly

0.18

kg

Included products

Lock nut

[KM 8](#)

Locking device

[MB 8](#)