

H 207

Dimensions

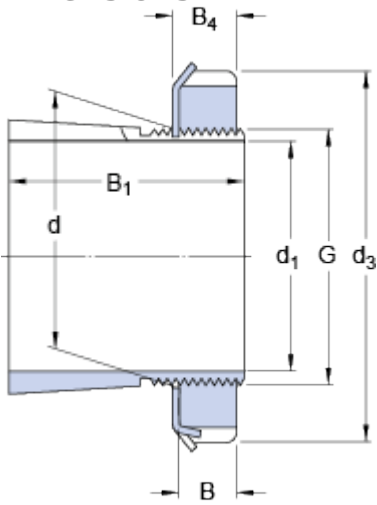

d_1	30	mm
d	35	mm
d_3	52	mm
B_1	29	mm
B	8	mm
B_4	9	mm
G	M 35x1.5	

Mass

Mass adapter sleeve assembly

0.14

kg

Included products

Lock nut

[KM 7](#)

Locking device

[MB 7](#)