

H 206

Dimensions

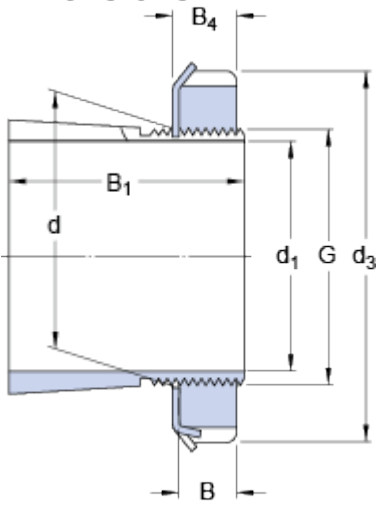

d_1	25	mm
d	30	mm
d_3	45	mm
B_1	27	mm
B	7	mm
B_4	8	mm
G	M 30x1.5	

Mass

Mass adapter sleeve assembly

0.1 kg

Included products

Lock nut

[KM 6](#)

Locking device

[MB 6](#)