

H 205

Dimensions

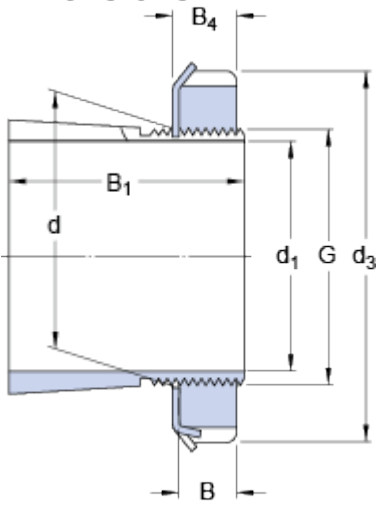

d_1	20	mm
d	25	mm
d_3	38	mm
B_1	26	mm
B	7	mm
B_4	8	mm
G	M 25x1.5	

Mass

Mass adapter sleeve assembly

0.08

kg

Included products

Lock nut

[KM 5](#)

Locking device

[MB 5](#)