

HK 5025

Dimensions

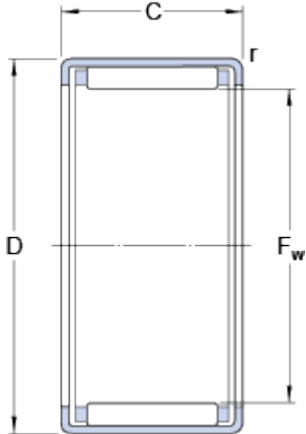

F _w	50	mm
D	58	mm
C	25	mm
r	min. 0.8	mm

Calculation data

Basic dynamic load rating	C	36.9	kN
Basic static load rating	C	85	kN
Fatigue load limit	P _u	10.6	kN
Reference speed		5000	r/min
Limiting speed		5600	r/min

Mass

Mass bearing	0.085	kg
Designation	HK 5025	

Associated products

Inner ring IR series	IR 45x50x25.5
Inner ring LR series	LR 45x50x25.5
Radial shaft seal with a low cross-sectional height, single lip	G 50x58x4
Radial shaft seal with a low cross-sectional height, double lip	SD 50x58x4