

HK 3520

Dimensions

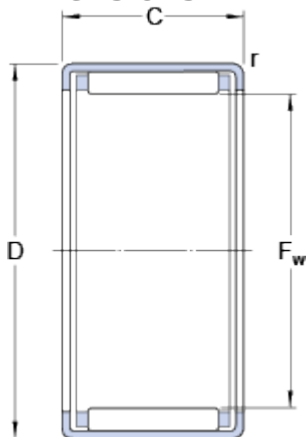

F _w	35	mm
D	42	mm
C	20	mm
r	min. 0.8	mm

Calculation data

Basic dynamic load rating	C	22.9	kN
Basic static load rating	C	46.5	kN
Fatigue load limit	P _u	5.6	kN
Reference speed		7000	r/min
Limiting speed		8000	r/min

Mass

Mass bearing	0.044	kg
Designation	HK 3520	

Associated products

Inner ring IR series	IR 30x35x20.5
Inner ring LR series	LR 30x35x20.5
Radial shaft seal with a low cross-sectional height, single lip	G 35x42x4
Radial shaft seal with a low cross-sectional height, double lip	SD 35x42x4