

HK 3038

Dimensions

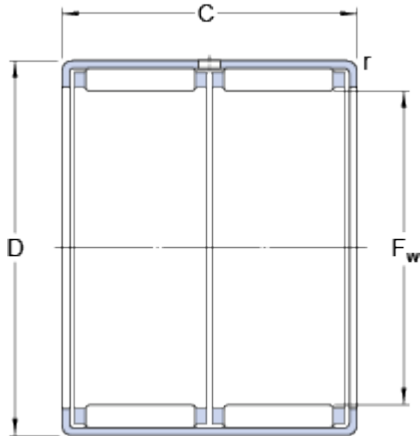

F _w	30	mm
D	37	mm
C	38	mm
r	min. 0.8	mm

Calculation data

Basic dynamic load rating	C	35.8	kN
Basic static load rating	C	80	kN
Fatigue load limit	P _u	9.5	kN
Reference speed		8000	r/min
Limiting speed		9000	r/min

Mass

Mass bearing	0.076	kg
Designation	HK 3038	

Associated products

Inner ring IR series	IR 25x30x38.5
Inner ring LR series	LR 25x30x38.5
Radial shaft seal with a low cross-sectional height, single lip	G 30x37x4
Radial shaft seal with a low cross-sectional height, double lip	SD 30x37x4