

HK 2526

Dimensions

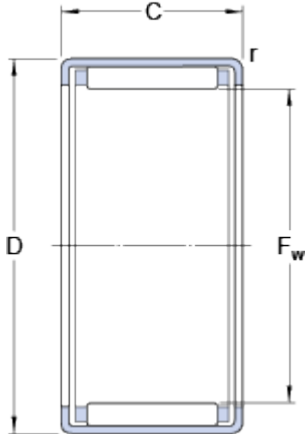

F _w	25	mm
D	32	mm
C	26	mm
r	min. 0.8	mm

Calculation data

Basic dynamic load rating	C	24.2	kN
Basic static load rating	C	45	kN
Fatigue load limit	P _u	5.5	kN
Reference speed		9500	r/min
Limiting speed		11000	r/min

Mass

Mass bearing		0.044	kg
Designation		HK 2526	

Associated products

Inner ring IR series	IR 20x25x26.5
Inner ring LR series	LR 20x25x26.5
Radial shaft seal with a low cross-sectional height, single lip	G 25x32x4