

# HK 2030

## Dimensions

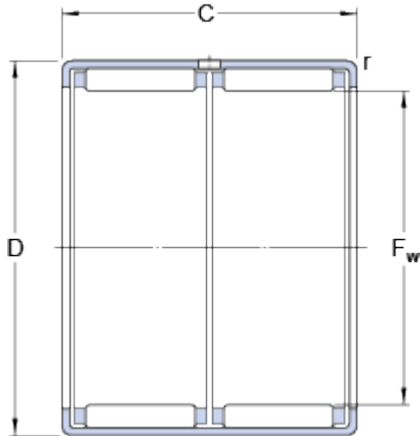

F <sub>w</sub>	20	mm
D	26	mm
C	30	mm
r	min. 0.8	mm

## Calculation data

Basic dynamic load rating	C	20.9	kN
Basic static load rating	C	40.5	kN
Fatigue load limit	P <sub>u</sub>	4.75	kN
Reference speed		12000	r/min
Limiting speed		14000	r/min

## Mass

Mass bearing		0.035	kg
Designation		HK 2030	

## Associated products

Inner ring IR series	IR 17x20x30.5
Inner ring LR series	LR 17x20x30.5
Radial shaft seal with a low cross-sectional height, single lip	<a href="#">G 20x26x4</a>
Radial shaft seal with a low cross-sectional height, double lip	<a href="#">SD 20x26x4</a>