

HK 2012

Dimensions

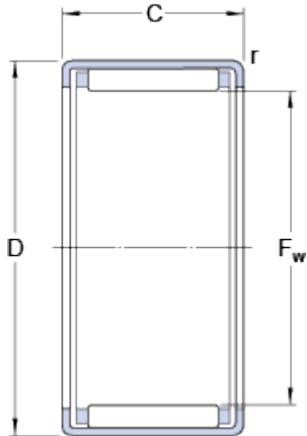

F_w	20	mm
D	26	mm
C	12	mm
r	min. 0.8	mm

Calculation data

Basic dynamic load rating	C	8.42	kN
Basic static load rating	C	12.5	kN
Fatigue load limit	P_u	1.4	kN
Reference speed		12000	r/min
Limiting speed		14000	r/min

Mass

Mass bearing		0.014	kg
Designation		HK 2012	

Associated products

Inner ring IR series		IR 15x20x13
Radial shaft seal with a low cross-sectional height, single lip		G 20x26x4
Radial shaft seal with a low cross-sectional height, double lip		SD 20x26x4