

HK 0910

Dimensions

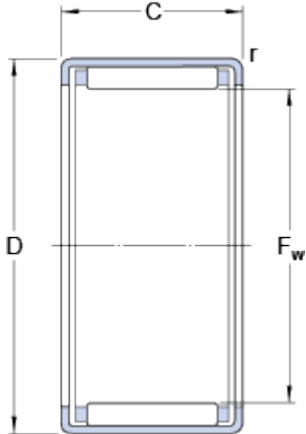

F_w	9	mm
D	13	mm
C	10	mm
r	min. 0.4	mm

Calculation data

Basic dynamic load rating	C	4.13	kN
Basic static load rating	C	4.8	kN
Fatigue load limit	P_u	0.53	kN
Reference speed		18000	r/min
Limiting speed		20000	r/min

Mass

Mass bearing		0.004	kg
Designation		HK 0910	

Associated products

Radial shaft seal with a low cross-sectional height, single lip

[G 9x13x3](#)