

G 40x52x5

Dimensions

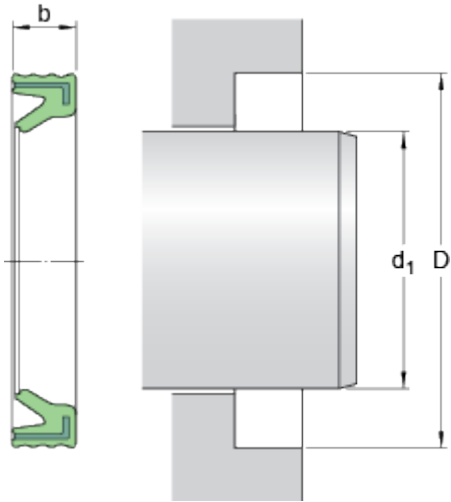

d_1	40	mm
D	52	mm
b	5	mm

Application and operating conditions

Operating temperature	min.	-30	°C
Operating temperature	max.	110	°C
Shaft surface speed	max.	10	m/s